

Ideal Standard i.life B 80cm Wall Hung Vanity Unit

ILLUSTRATED

- T5272** Ideal Standard i.life B 80cm wall hung vanity unit with 2 drawers
- T4604** Ideal Standard i.life B 81cm vanity washbasin, 1 taphole
- E0157** Wall fixing set
- BD246** Ceraplan single lever basin mixer, with click waste
- EE230339** Space saving trap and waste pipe assembly for use with furniture basin units
- T5326** i.life 36cm handle

ILLUSTRATED PRODUCT DETAILS







Weights

- E0157** 0.16 KG
- BD246** 1.77 KG
- EE230339** 0.10 KG

Materials

- T5272** Mixed Material
- T4604** Fine Fireclay
- E0157** Metal
- BD246** Chrome Plated Brass
- EE230339** Plastic

Finishes

- T5272**  Matt White (DU)
- T4604**  White (01)
- E0157**  Neutral / No Finish (67)
- BD246**  Chrome (AA)
- EE230339**  Neutral / No Finish (67)
- T5326**  Silk Black (XG)

Flow rates

- BD246** 5 Litres per minute @ 3 bar pressure

Designer

Palomba Serafini Associati

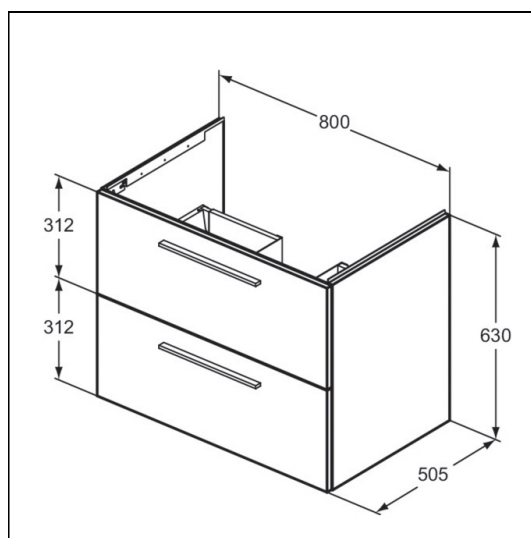

FINISH OPTIONS

- | | | |
|---|---|---|
|  |  |  |
| (DU) Matt White | (NF) Matt Sandy Beige | (NG) Matt Quartz Grey |
|  |  |  |
| (NH) Matt Griega | (NW) Coffee Oak | (NX) Natural Oak |
|  |  |  |
| (NV) Matt Carbon Grey | (XG) Silk Black | (YE) Brushed Chrome |

Standards

EN 14749:2005

Special Notes

Furniture units should be installed in a bathroom with adequate ventilation. Mounting kit included. Always use appropriate fixings to suit the type of wall.

