

## Technical Data Information

**Product Code:** KS11080

**Information:** SURFACE MATERIAL: Acrylic Capped ABS  
REINFORCEMENT: Resin Bonded Stone  
TRAY HEIGHT: 45mm  
PLINTH HEIGHT (OPTIONAL): 100mm  
WEIGHT: 35kg  
CE CERT: BS EN 14527 - Class 1 Shower Tray  
COMMODITY CODE: 39229000

**Overall Dimensions:** L: 1100 x W: 800

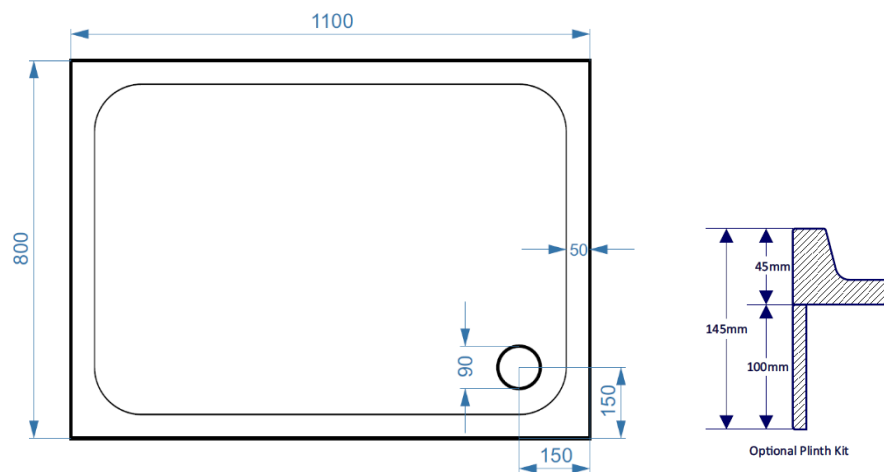

All measurement stated in mm to tolerance of +/-5mm

All Dimensions are in millimetres. The information contained on this page was correct at date of issue. Fitting dimensions are provided as a guide only. Some variation may occur due to manufacturing tolerances. We pursue a policy of continuing improvement in design and performance of our products and so reserve the right to change specifications without prior notice.