

Technical Data Information

Product Code: KS10080

Information: SURFACE MATERIAL: Acrylic Capped ABS
REINFORCEMENT: Resin Bonded Stone
TRAY HEIGHT: 45mm
PLINTH HEIGHT (OPTIONAL): 100mm
WEIGHT: 34kg
CE CERT: BS EN 14527 - Class 1 Shower Tray
COMMODITY CODE: 39229000

Overall Dimensions: L: 1000 x W: 800

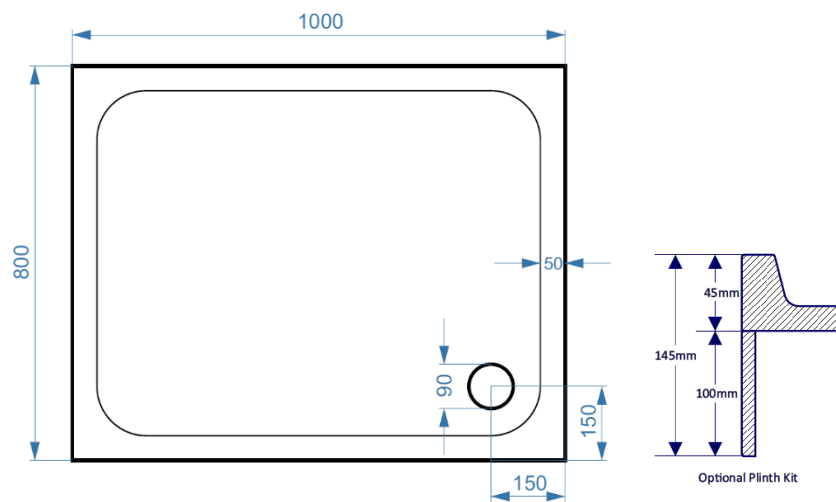

All measurement stated in mm to tolerance of +/-5mm

All Dimensions are in millimetres. The information contained on this page was correct at date of issue. Fitting dimensions are provided as a guide only. Some variation may occur due to manufacturing tolerances. We pursue a policy of continuing improvement in design and performance of our products and so reserve the right to change specifications without prior notice.